

# SM104Module

User Guide V2.01





---



## USING THE UNIT SAFELY

### INSTRUCTIONS FOR THE PREVENTION OF FIRE, ELECTRIC SHOCK, OR INJURY TO PERSONS

About ⚠ WARNING and ⚠ CAUTION Notices.





 WARNING	Used for instructions intended to alert the user to the risk of death or severe injury should the unit be used improperly.
 CAUTION	Used for instructions intended to alert the user to the risk of injury or material damage should the unit be used improperly. *Material damage refers to damage or other adverse effects caused with respect to the home and all its furnishings, as well to domestic animals or pets.

※About the Symbols

	The ⚠ symbol alerts the user to important instructions or warnings. The specific meaning of the symbol is determined by the design contained within the triangle. In the case of the symbol at left, it is used for general cautions, warnings, or alerts to danger.
	The ⚡ symbol alerts the user to things that must be carried out. The specific thing that must be done is indicated by the design contained within the circle. In the case of the symbol at left, it means that the power-cord plug must be unplugged from the outlet.
	The ⚡ symbol alerts the user to items that must never be carried out (are forbidden). The specific thing that must not be done is indicated by the design contained within the circle. In the case of the symbol at left, it means that the unit must never be disassembled.

---

#### ⚠ WARNING

-  Please connect the power plug with ground protected power outlet.
-  Do not open (or modify in any way) the unit or its AC adapter.
-  Do not attempt to repair the unit, or replace parts within it (except when this manual provides specific instructions directing you to do so).
-  Never use or store the unit in places that are: Subject to temperature extremes (e.g., direct sunlight in an enclosed vehicle, near a heating duct, on top of heat-generating equipment); or are damp (e.g., baths, washrooms, on wet floors); or are humid; or are exposed to rain; or are dusty; or are subject to high levels of vibration.

-  When using the unit with a rack or stand, the rack or stand must be carefully placed so it is level and sure to remain stable. If not using a rack or stand, you still need to make sure that any location you choose for placing the unit provides a level surface that will properly support the unit, and keep it from wobbling.
-



Be sure to use only the AC adapter supplied with the unit. Also, make sure the line voltage at the installation matches the input voltage specified on the AC adapter's body. Other AC adapters may use a different polarity, or be designed for a different voltage, so their use could result in damage, malfunction, or electric shock.



Use only the attached power-supply cord. Also, the supplied power cord must not be used with any other device.



Do not excessively twist or bend the power cord, nor place heavy objects on it. It can damage the cord, producing severed elements and short circuits. Damaged cords may cause fire and shock hazards!



This unit, either alone or in combination with an amplifier and headphones or speakers, may be capable of producing sound levels that could cause permanent hearing loss. Do not operate for a long period of time at a level that is uncomfortable. If you experience any hearing loss or ringing in the ears, you should immediately stop using the unit, and consult an audiologist.



Do not allow any objects (e.g., flammable material, coins, pins); or liquids of any kind (water, soft drinks, etc.) to penetrate the unit.



Immediately turn the power off and remove the AC adapter from the outlet when:

- a. The AC adapter, the power-supply cord, or the plug has been damaged.
- b. Smoke or unusual odor occurs.
- c. Objects have fallen into, or liquid has been spilled onto the unit.
- d. The unit has been exposed to rain (or otherwise has become wet).
- e. The unit does not appear to operate normally or exhibits a marked change in performance.



In Households with small children, an adult should provide supervision until the child is capable of following all the rules essential for the safe operation of the unit.



Protect the unit from strong impact. (Do not drop it!)



Do not force the unit's power-supply cord to share an outlet with an unreasonable number of other devices. Be especially careful when using extension cords—the total power used by all devices you have connected to the extension cord's outlet must never exceed the power rating (watts/amperes) for the extension cord. Excessive loads can cause the insulation on the cord to heat up and eventually melt through.

⚠ CAUTION



The unit and the AC adapter should be located so their location or position does not interfere with their proper ventilation.



Always grasp only the plug on the AC adapter cord when plugging into, or unplugging from, an outlet or this unit.



At regular intervals, you should unplug the AC adapter and clean it by using a dry cloth to wipe all dust and other accumulations away from its prongs. Also, disconnect the power plug from the power outlet whenever the unit is to remain unused for an extended period of time. Any accumulation of dust between the power plug and the power outlet can result in poor insulation and lead to fire.



Try to prevent cords and cables from becoming entangled. Also, all cords and cables should be placed so they are out of reach of children.



Never climb on top of, nor place heavy objects on the unit.



Never handle the AC adapter or its plugs with wet hands when plugging into, or unplugging from, an outlet or this unit.



Before moving the unit, disconnect the AC adapter and all cords coming from external devices.



Before cleaning the unit, turn off the power and unplug the AC adapter from the outlet.



Whenever you suspect the possibility of lightning in your area, disconnect the AC adapter from the outlet.



Keep any caps you may remove and the included wing bolts in a safe place out of children's reach, so there is no chance of them being swallowed accidentally.

IMPORTANT NOTES!
------------------

## Power supply

- Do not connect this unit to same electrical outlet that is being used by an electrical appliance that is controlled by an inverter (such as a refrigerator, washing machine, microwave oven, or air conditioner), or that contains a motor. Depending on the way in which the electrical appliance is used, power supply noise may cause this unit to malfunction or may produce audible noise. If it is not practical to use a separate electrical outlet, connect a power supply noise filter between this unit and the electrical outlet.
- The AC adapter will begin to generate heat after long hours of consecutive use. This is normal, and is not a cause for concern.
- Before connecting this unit to other devices, turn off the power to all units. This will help prevent malfunctions and/or damage to speakers or other devices.

## Placement

- Using the unit near power amplifiers (or other equipment containing large power transformers) may induce hum. To alleviate the problem, change the orientation of this unit; or move it farther away from the source of interference.
  - This device may interfere with radio and television reception. Do not use this device in the vicinity of such receivers.
-

- 
- Noise may be produced if wireless communications devices, such as cell phones, are operated in the vicinity of this unit. Such noise could occur when receiving or initiating a call, or while conversing. Should you experience such problems, you should relocate such wireless devices so they are at a greater distance from this unit, or switch them off.
  - Do not expose the unit to direct sunlight, place it near devices that radiate heat, leave it inside an enclosed vehicle, or otherwise subject it to temperature extremes. Excessive heat can deform or discolor the unit.
  - When moved from one location to another where the temperature and/or humidity is very different, water droplets (condensation) may form inside the unit. Damage or malfunction may result if you attempt to use the unit in this condition. Therefore, before using the unit, you must allow it to stand for several hours, until the condensation has completely evaporated.

## Maintenance

- For everyday cleaning, wipe the unit with a soft, dry cloth or one that has been slightly dampened with water. To remove stubborn dirt, use a cloth impregnated with a mild, non-abrasive detergent. Afterwards, be sure to wipe the unit thoroughly with a soft, dry cloth.
- Never use benzene, thinners, alcohol or solvents of any kind, to avoid the possibility of discoloration and/or deformation.

## Other attentions

- Please be aware that the unit's memory can be irretrievably lost as a result of a malfunction, or the improper operation of the unit.
  - Please take care when using the unit's buttons or other controls, and when using its jacks and connectors. Rough handling can lead to malfunctions.
  - Never strike or apply strong pressure to the display.
  - When connecting/disconnecting all cables, grasp the connector itself—never pull on the cable. This way you will avoid causing shorts, or damage to the cable's internal elements.
  - To avoid disturbing your neighbors, try to keep the unit's volume at reasonable levels. You may prefer to use headphones, so you do not need to be concerned about those around you.
  - Since sound vibrations can be transmitted through floors and walls to a greater degree than expected, take care not to allow such sound to become a nuisance to neighbors, especially at night and when using headphones.
  - When you need to transport the unit, package it in the box (including padding) that it came in, if possible. Otherwise, you will need to use equivalent packaging materials.
  - Some connection cables contain resistors. Do not use cables that incorporate resistors for connecting to this unit. The use of such cables can cause the sound level to be extremely low, or impossible to hear.
-

---

# Contents

## 1. Introduction

1.1 Components .....	1
1.1.1 Top and rear panels .....	1
1.1.2 Jack Panel .....	2
1.2 Getting ready to play .....	3
1.2.1 Turning the power on .....	3
1.2.2 Turning the power off .....	3
1.3 Basic concepts .....	3

## 2. Performing

2.1 Selecting a drum kit .....	3
2.2 Creating a drum kit .....	3
2.3 Edit the drum kit .....	4
2.3.1 Selecting an instrument .....	4
2.3.2 Using the Muffling .....	4
2.3.3 Using the Mixer .....	4

## 3. Playing along with music

3.1 Playing with the internal songs .....	5
3.1.1 Song Function profile .....	5
3.1.2 Song selection .....	5
3.1.3 Playing a song .....	5
3.1.4 Setting the tempo .....	6
3.1.5 Muting the drum part .....	6
3.1.6 Viewing song information/Editing song settings .....	6
3.1.7 Using the Repeat function (Repeat) .....	6
3.2 Using the AUX IN .....	6
3.2.1 Connections .....	6
3.2.2 Playback .....	6

## 4. Practicing

4.1 On Board Metronome .....	7
4.1.1 Using the metronome .....	7
4.1.2 Metronome parameters .....	7
4.2 Recording and playback (REC/PLAY) .....	8

---

---

4.2.1 Recording	8
4.2.2 Save recorded data	8
4.2.3 Playback	8
4.3 Using the Coach function (COACH)	9
<b>5. Advanced applications</b>	
5.1 Optimizing the pad settings	9
5.2 MIDI-related settings	12
5.3 Other settings (Utility)	14
5.3.1 Adjusting the display contrast(LCD Contrast)	14
5.3.2 Restoring the factory settings	14

---



---

# 1. Introduction

## 1.1 Components

### 1.1.1. Top and rear panels

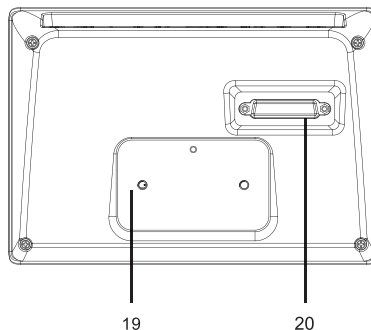
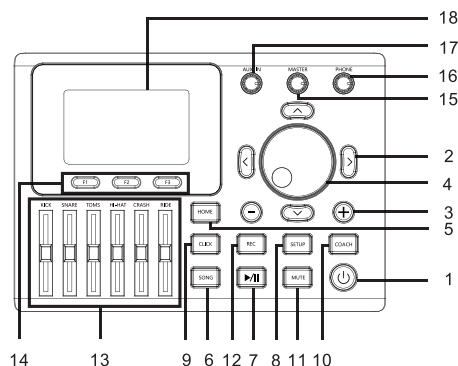

#### 1. Power button

Turns the power on/off.

#### 2. Cursor buttons (< > V Λ)

Use these buttons to move the cursor on the screen.

#### 3. [+]button, [-]button

Use these buttons to switch drum kits or to edit a value. Pressing the [+] button increases the value, and pressing the [-] button decreases it.

#### 4. Rotary

This rotary has the same function as the [+] and [-] buttons. Use the rotary when you want to quickly change the drum kit or value in large steps.

#### 5. HOME button

Press this to access the basic KIT screen.

#### 6. SONG button

Press this to play back a song or access the song-related settings.

#### 7. Play/Pause button

Press to play back or stop a song.

#### 8. SETUP button

Use this to make settings such as MIDI, triggering, pad sensitivity etc.

#### 9. CLICK button

Turns the metronome on/off.

#### 10. COACH button

This activates the Coach function, allowing you to view your timing on the screen.

#### 11. MUTE button

When a song is playing back, use this button to mute the drum part.

#### 12. REC button

Use this to record your playing.

#### 13. Volume slider for each pad

Slide the buttons to change the volumes of pads.

---

## 14. F1–F3 button(function buttons )

The functions of these buttons will change depending on the screen that is displayed. Press [F3] button on Home screen to open X–stick function.

## 15. Master knob

Adjusts the volume from the L, R Output jacks.

## 16. PHONE knob

Adjusts the volume from PHONE jack.

## 17. Aux in knob

Adjusts the volume from jack.

### 1.1.2 Jack panel

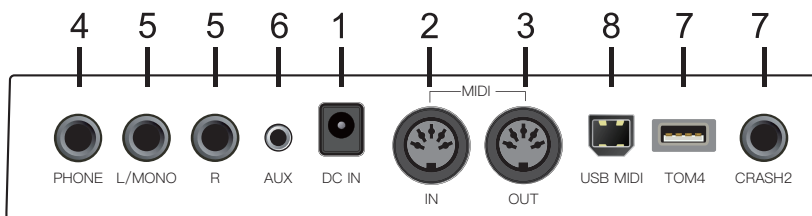

#### 1. DC IN jack

Connect the included power adapter here.

#### 2. MIDI IN connector

Use this for triggering sounds in the module via a MIDI sequencer.

#### 3. MIDI OUT connector

Use this when you want to use the pads to play external MIDI sound sources.

#### 4. PHONE OUTPUT jack

Use for connecting stereo headphones.

## 18. Screen

This shows the drum kit name in playing mode, or other information displays will appear.

## 19. Sound module mounting holes

Attach the sound module mounting plate here.

## 20. Trigger Input connector

Connecting the special cable connects the pads and pedals to the module.

#### 5. LINE OUTPUT jack

Use for connecting to an amp Or other external audio equipment.

#### 6. AUX jack

Use for connecting an external audio source such as MP3 or CD players.

#### 7. TRIGGER IN jack (TOM 4, CRASH 2)

Use these jacks to add more pads. (The TOM 4 jack can only be connected with specific pad, otherwise it will cause damage to the device.)

#### 8. USB MIDI

For use as MIDI device to connect PC.

## 1.2 Getting ready to play

### 1.2.1 Turning the power on

1. Turn “VOLUME KNOB” all the way to the left.
2. Do the same with the connected amp or audio system.
3. Press [POWER] button.
4. Power on the connected amp or audio system.
5. While hitting a pad, gradually turn “VOLUME” toward the right to adjust the volume.

※ After you turn on the power, do NOT touch any pads or pedals until the home screen appears.

### 1.2.2 Turning the power off

1. Turn the volume down on the module and any connected equipment.
2. Hold down [POWER] button until the screen indicates “POWER OFF”.
3. Release [POWER] button.

## 1.3 Basic concepts

### 1.3.1 Save your settings

Any changed you make will be saved automatically after normal power off.

### 1.3.2 Cursor

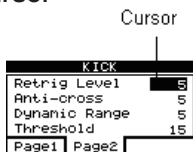

The cursor is the highlighted text in the screen that indicates what you can edit. If there is several editable item in a screen, you can use the “CURSOR” or [+]/[-] buttons to move the cursor to the item you want to edit.

## 2. Performing

### 2.1 Selecting a drum kit

- ◇ This is the Home Page screen; it appears when you press [HOME] button.

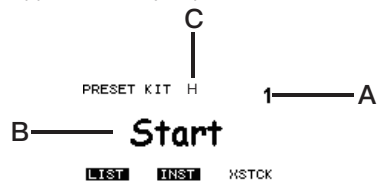

A	Drum kit number.
B	Drum kit name.
C	Indicates “H, T1, S” for Head shot or “R” for Rim Shot.

- ◇ Use the [+]/[-] buttons or “Rotary” to select a drum kit.

### 2.2 Creating a drum kit

You can create a name of up to ten characters for each drum kit.

1. Press [HOME]–[F1] (LIST), The “LIST” screen appears.



2. Press [F3] (NEW), The “NEW” screen appears.



- Use “CURSOR” or “Rotary” to move the cursor to the character that you want to edit.
- Using [F1]–[F3] button to change the character.

Function	Explanation
F1 (ENTER)	Enters the character of the cursor location to drum kit name.
F2 (<-)	Deletes the character or the cursor location, and moves subsequent characters one place to the left.
F3 (SAVE)	Save the drum kit name.

## 2.3 Edit the drum kit

In the home page “Drum Kit” screen, Use “Rotary” or [+]/[-] to choose the drum kit you want to edit.

### 2.3.1 Selecting an instrument

On the module, all sounds are referred to as “instrument”.

- Press [HOME]–[F2] (INST),  
The “INST Page 1” screen appears.



- Press [F1] (TONE),  
The “TONE” screen appears.



- Hit the desired pad or use CURSOR [<][>] to select a pad.

- Use [+]/[-] or “Rotary” to move the cursor to instrument.
- Press [F3] (BACK) button or press [HOME] button return to “Drum Kit” screen. The setting will be saved automatically.

### 2.3.2 Using the Muffling

Adjusting the volume and pan (stereo position) of individual pads/pedals.

- In the “INST Page 1” screen, press [F2] (MFL),  
The “Muffling” screen appears.

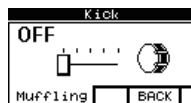

- Hit the desired pad or use CURSOR [<][>] to select a pad.
- Use [+]/[-] or “Rotary” to edit the value.
- Press [F3] (BACK) button or press [HOME] button return to “Drum Kit” screen. The setting will be saved automatically.

### 2.3.3 Using the Mixer

Adjusting the volume and pan (stereo position) of individual pads/pedals.

- In the “INST Page 1” screen, press [>] button to “INST Page 2”



- Press [F1]–[F2] to select the item you want to edit.

Screen	Parameter	Value	Description
	F1 (PAN)	0-127	Pan position of each pad
	F2 (VOL)	0-127	Volume of each pad

- Hit the desired pad or use CURSOR [[>)] to select a pad.
- Use [+]/[-] or “Rotary” to edit the value.
- Press [F3] (BACK) button or press [HOME] button return to “Drum Kit” screen. The setting will be saved automatically.

### 3. Playing along with music

#### 3.1 Playing with the internal songs

##### 3.1.1 Song Function profile

- ◇ The internal songs consist of “drum”, “piano”, “bass” and “other” parts.
- ◇ Each part can be muted individually.
- ◇ The tempo for these songs can also be adjusted.

A	Song name. Indicates the name of the currently selected song.
B	Song playback type. Press [^] to change the type.
C	Measure number. When you press [Play/Pause], playback begins from the measure shown here.
D	Beat
E	Song volume

##### 3.1.2 Song selection

- Press [SONG] button, the “Song” screen appears.



- Use [[>)] to select a song.

What's in “Song” screen:

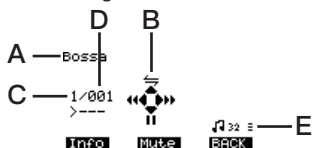

##### 3.1.3 Playing a song

- Use [[>)] to select the song you want to play.
- Use [+]/[-] or “Rotary” to change the volume.
- Press [Play/Pause] button, the song will begin playing.
- Press [Play/Pause] again, stop playback song.

### 3.1.4 Setting the tempo

1. Press [CLICK] and [V] button in the same time, the “TEMPO” screen appears.



2. Use [+]/[-] or “Rotary” to adjust the tempo.

### 3.1.5 Muting the drum part

You can mute the playback of a specific part in a song.

1. Press [SONG]-[F2] (Mute), the “MUTE” screen appears.

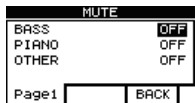

2. Use [^][V] to move the cursor.
3. Use [+]/[-] or “Rotary” to mute on/off for each part.
4. Each time you press [MUTE], the drum part will be muted or nu-muted.

### 3.1.6 Viewing song information/ Editing song settings

1. Press [SONG]-[F1] (Info), The “Information” screen appears.

```
Name      88's Rock
Length    14368
Time Signature  4/4
Tempo     150
```

Parameter	Parameter
Name	Song Name
Length	Number of bytes
Time Signature	Time signature
Tempo	Song Tempo

### 3.1.7 Using the Repeat function (Repeat)

This function allows you to select a specific section of a song and have it repeat.

1. Select the song that you want to play, and press [Play/Pause]. The song will begin playing.
  2. To mark the beginning of the section you want to repeat, press [^] (Rpt).
  3. At the end of the section you want to repeat, press [^] (Rpt).
  4. To cancel the Repeat function, press [^] (Rpt) once again.
- ◇ The minimum repeat length is 1 measure.

## 3.2 Using the AUX IN

By connecting a portable audio/CD player to the AUX IN jack you can play the module with your favorite songs.

### 3.2.1 Connections

- ◇ Before making connections, please lower the volume of module.
- ◇ If a connection cable has build-in resistors, the volume level of the source connected to the module (AUX IN) may be lower.

### 3.2.2 Playback

1. Start the music on your portable audio player.
  2. Adjust the volume.
- ◇ Sounds received on the AUX IN are output to the LINE OUTPUT and HEADPHONE OUTPUT jack.
  - ◇ Adjust the volume on the audio player to get the right balance between it and the module.

## 4. Practicing

### 4.1 On Board Metronome

Practicing with the built in metronome will help you perfect your tempo skills.

#### 4.1.1 Using the metronome

1. Press the [CLICK] button, the metronome starts.
2. Press the [CLICK] button again to stop it.

#### 4.1.2 Metronome parameters

You can change the tempo, sound and time signature of the metronome.

1. Press [CLICK] and [V] button in the same time, the “TEMPO” screen appears.



2. Use [+] / [-] or “Rotary” to edit the value, value: 20–240.
3. Press [F1] (SETUP), the “CLICK SETUP” screen appears.

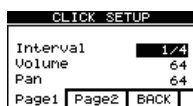

4. Press [F1] (Page 1) or [F2] (Page 2) to choose the page containing the parameter you want to change.

Parameter	Value	Description
Interval	1/2 (half note)	Click Interval
	3/8 (clotted quarter note)	
	1/4 (quarter note)	
	1/8 (eighth note)	
	1/12 (eighth note triplets)	
	1/16 (16 <sup>th</sup> note)	
Volume	0–127	Volume of the metronome sound
Pan	0–127	Panning of sound
Numerator	0–32	Metronome’s time signature
Denominator	1, 2, 3, 4, 8, 16, 32, 64	
Instrument A	Instruments	All drum kit sound instruments
Instrument B		

5. Use CURSOR [^][V] to select a parameter.
6. Use the [+] / [-] or “Rotary” to edit the value.
7. Press [F3] (BACK) button or press [HOME] button return to “Drum Kit” screen. The setting will be saved automatically.

## 4.2 Recording and playback (REC/PLAY)

### 4.2.1 Recording

1. Press [REC],  
the “MIDI RECORDER” screen appears.



2. Press [REC] button again,  
the “Recording” screen appears.



3. Hit any pad/pedal and recording begins.
4. To stop recording, Press [REC] button.  
The “Record Finish” screen appears.



- ◇ If you exceed the maximum recording number (5000 times hit), recording stops automatically.
- ◇ Previously recorded data will be erased when a new recording starts.
- ◇ The previously recorded data will be erased when leave the “MIDI RECORDER” screen without saving action.

### 4.2.2 Save recorded data

1. When recording finished, press [F3] (SAVE),  
the “SAVE” screen appears.



2. Use CURSOR to move the cursor to the desired character.
3. Use function button [F1] –[F3].

Function	Explanation
F1 (ENTER)	Enter the desired character.
F2 (<-)	Delete the last character.
F3 (Save)	Save the recorded data.

### 4.2.3 Playback

1. Press [REC] button,  
the “MIDI RECORDER” screen appears.



2. Use [+] / [-] or “Rotary” to select the recorded data.
3. Press [F1] (PLAY) to playback.
4. When playback has ended,  
the “Play Finish” screen appears.



- ◆ If MUTE function is effect, you can't playback the recorded data.



### 4.3 Using the Coach function

The Coach function provides an on-screen view of the timing of your drumming.

1. Press [COACH] button, the “COACH” screen appears.

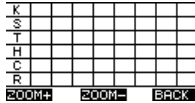

2. Play the pads, your timing will be showing the display.
  - ◇ [F1] (ZOOM+) button, Each time you press this button, the display of one beat will be magnified. This lets you view one beat in greater detail.
  - ◇ [F2] (ZOOM-) button, Each time you press this button, the viewing area will expand. This lets you view more beats at once.

## 5. Advanced applications

### 5.1 Optimizing the pad settings

1. Press [SETUP], the “SETUP” screen appears.





2. Press [F1] (Trig) , the “Trig” screen appears.
3. Press [F1] (Page 1)–[F2] (Page 2)to choose the item that you want to edit.
4. Use CURSOR to select a parameter.
5. Use [+]/[-] or “Rotary” to edit the value of the parameter.
6. Press [F3] (BACK) button or press [HOME] button return to “Drum Kit” screen. The setting will be saved automatically.

### [F1] (Page 1) 、 [F2] (Page 2) Trigger Parameter Description

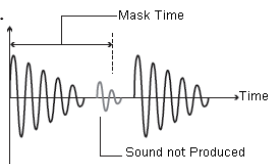
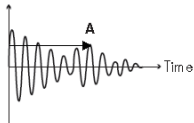
Screen	Parameter	Value	Description
[F1] (Page 1) 	Type	KICK SNARE TOM 1- 4 HI-HAT CRASH 1-2 SNARERIM TOM1-4RIM RIDE PEDAL	◇ The trigger type is a collection of parameters optimized for specific models of pad.
	Sensibility	1-32	◇ You can adjust the sensitivity of the pads to accommodate your personal playing style. ◇ This allows you to have more dynamic control, over the sound volume, based on how hard you play. ◇ Lower sensitivity will keep the pad producing a low volume even when played forcefully.
	Curve	Linear Log Exp	◇ This setting allows you to control the relation between playing velocity (striking force) and changes in volume. ◇ Linear type is the default type.

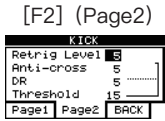
Screen	Parameter	Value	Description
	Mask Time	1-32	<ul style="list-style-type: none"> <li>◇ This setting prevents double triggering.</li> <li>◇ When playing a trigger (specially kick trigger), the beater can bounce back and hit the head a second time immediately after the intended note—with acoustic drums sometimes the beater stays against the head—this causes a single hit to “double trigger” (two sounds instead of one).</li> <li>◇ The Mask Time setting helps to prevent this. Once a pad has been hit, any additional trigger signals occurring within the specified “Mask Time” will be ignored.</li> <li>◇ When set to high value, it will be difficult to play very quickly. Set this to as low a value as you can.</li> </ul>  <ul style="list-style-type: none"> <li>◇ If two or more sounds are being produced when you strike the head just once, then adjust Retrig Level.</li> </ul>
[F2] (Page2)	Retrig Level	1-10	<ul style="list-style-type: none"> <li>◇ This setting prevents spurious re-triggering.</li> <li>◇ Important if you are using acoustic drum triggers. Such triggers can produce altered waveforms, which may also cause inadvertent sounding at Point A in the following figure (Re-trigger).</li> </ul>  <ul style="list-style-type: none"> <li>◇ This occurs in particular at the decaying edge of the waveform.</li> <li>◇ Re-trigger Level detects such distortion in and prevents re-triggering from occurring.</li> <li>◇ When set to high value, it will be difficult to play very quickly.</li> </ul>
	Anti-cross	1-10	<ul style="list-style-type: none"> <li>◇ This setting allows a trigger signal to be received only when the pad is above a determined dynamic level (velocity). This can be used to prevent a pad from sounding because of vibrations from other pad. In the following example, B will sound but A and C will not sound.</li> </ul>

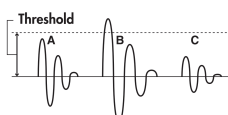

Screen	Parameter	Value	Description
			 <ul style="list-style-type: none"> <li>◇ When set to a higher value, no sound is produced when the pad is struck lightly. Gradually raise the “Anti cross” value while striking the pad.</li> <li>◇ Check this and adjust accordingly.</li> <li>◇ Repeat this process until you get the perfect setting for your playing style.</li> </ul>
	Dynamic Range	1–10	<ul style="list-style-type: none"> <li>◇ This setting allows a trigger signal to be received range between peak value with minimum value.</li> <li>◇ When set to higher value, it will be larger range for the trigger signal.</li> </ul>
	Threshold	1–32	<ul style="list-style-type: none"> <li>◇ This setting is to adjust the allowed min. striking force for generating sounds.</li> <li>◇ When set to higher value, there is no sound for slight hit.</li> </ul> 

◇ You can change to default trigger settings that are specified when you execute a Factory Reset.

### Hi-Hat pedal parameter description

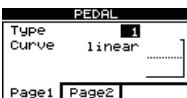
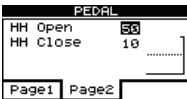
Screen	Parameter	Value	Description
	Type	1–3	1: Pedal PDL–HH171 (Default) 2: Hi-hat DET–HH181 3: Other
	Curve	Linear Max	Linear: The volume changes by the striking force (Default) M a x : The volume is at the max no matter how hard you strike.
	HH Open Value	1–64	The Hi-hat open higher when the value increases
	HH Close Value	1–64	The Hi-hat close lower when the value decreases
※HH Close value ≤ HH Open Value.			

◇ You can restore the pads to factory settings, see “Other settings”.

◇ Press [SETUP]–[F1] (TRIG), the “TRIG” screen appears, Step on Hi-Hat pedal, it will show the Hi-Hat pedal setting, or press [>] till find the Hi-Hat pedal setting.

## 5.2 MIDI-related settings

1. Press [SETUP] button, the “Setup” screen appears.



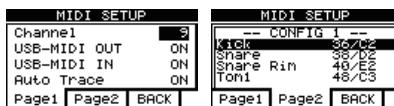

2. Press [F2] (MIDI), the “MIDI SETUP” screen appears.



3. Press [F1] (Page 1) or [F2] (Page2) to choose the item that you want to edit.
4. Use [+] / [-] or “Rotary” to edit the parameter.
5. Press [F3] (BACK) button or press [HOME] button return to “Drum Kit” screen. The setting will be saved automatically.

### [F1] (Page 1)、[F2] (Page 2) MIDI Parameter Description

Screen	Parameter	Value	Description
[F1] (Page 1) 	Channel	0–15	◇ MIDI channel number for transfer.
	USB-MIDI OUT	ON/OFF	◇ This setting allows module be used as a USB-MIDI device. Specifies whether MIDI message will be transmitted to an external MIDI device (ON) or not transmitted (OFF). ◇ Default value is ON.
	USB-MIDI IN	ON/OFF	◇ Specifies whether MIDI message sent from an external MIDI device will be received (ON) or not received (OFF). ◇ Default value is ON.
	Auto Trace	ON/OFF	◇ Turns the Note Chase on/off. ◇ This is convenient during the editing process. Received MIDI data will automatically call up the settings screen for the relative instrument/pad, and automatically moves the cursor. ◇ Default value is ON.
	Retransmit	ON/OFF	◇ This setting will allows the data from /to USB jack retransmit to/from MIDI jack. ◇ Default value is OFF.
	System Real	ON/OFF	◇ MIDI device information output. ◇ Default value is OFF.
	MIDI OUT	ON/OFF	◇ Specifies whether MIDI messages will be transmitted to an external MIDI device (ON) or not transmitted (OFF). ◇ Default value is ON.

Screen	Parameter	Value	Description
	MIDI IN	ON/OFF	<ul style="list-style-type: none"> <li>◇ Specifies whether MIDI messages sent from an external MIDI device will received (ON) or not received (OFF).</li> <li>◇ Default value is ON.</li> </ul>
<p>[F1] (Page 1)</p> 	Default MIDI Configuration	CONFIG 1-4	<ul style="list-style-type: none"> <li>◇ Can save 4 MIDI Configurations, press [&lt;] and [&gt;] to switch.</li> </ul>
	MIDI Code of a Pad	0-127	<ul style="list-style-type: none"> <li>◇ Specifies a MIDI code for a pad.               <ol style="list-style-type: none"> <li>a. When the MIDI code of several pads is same, “*” will appear before the MIDI code.</li> <li>b. Press [SETUP] to restore the CONFIG settings to default.</li> </ol> </li> </ul>

## 5.3 Other settings (Utility)

### 5.3.1 Adjusting the display contrast (LCD Contrast)

1. Press [SETUP]-[>] button, the “SETUP Page 2” screen appears.



2. Press [F1] (Util) , the “UTILITY” screen appears.

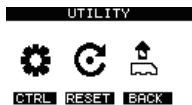

3. Press [F1] (CTRL), the “CONTROL” screen appears.



4. Use [+]/[-] or “Rotary” to edit value.
5. Press [F3] (BACK) button or press [HOME] button return to “Drum Kit” screen. The setting will be saved automatically.

- ◇ [F1] (Information)  
Current firmware version

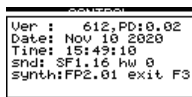

### 5.3.2 Restoring the factory settings

1. Press [SETUP]-[>] button, the “SETUP Page 2” screen appears.



2. Press [F1] (Util) , the “UTILITY” screen appears.

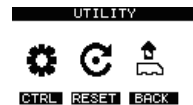

3. Press [F2] (RESET), the “RESET CONFIRM” screen appears.

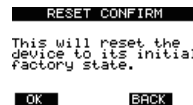

4. Press [F1] (OK), the restoring action will be done.
5. When the factory reset is finished, the screen will return to the “HOME” screen.





